

McIntosh
MA 5100

OWNER'S MANUAL

THE McINTOSH MA 5100 STEREO PREAMPLIFIER/POWER AMPLIFIER



\$1.25

Your MA 5100 stereo preamplifier/power amplifier will give you many years of pleasant and satisfactory performance. If you have any questions concerning the operation or maintenance of this instrument, please contact:

CUSTOMER SERVICE

McIntosh Laboratory Inc.
 2 Chambers Street
 Binghamton, New York 13903
 Phone: 607-723-3512

**Take Advantage of 3 years
 of FREE Factory Service . . .
 Fill in the Application NOW.**

CONTENTS

Guarantee	1
Installation	2, 3
How to Connect	3, 4, 5
What the Controls Do And How to Use Them	5, 6, 7
Balancing Your Stereo	7
Listening to Your Stereo	8
Performance Limits	8, 9
Typical Performance Charts	10
Technical Description	11
Block Diagrams	12

GUARANTEE

McIntosh Laboratory Incorporated guarantees this Instrument to be capable of performance as advertised. We also guarantee the mechanical and electrical workmanship and components to be free of defects for a period of 90 days from date of purchase. If such defects occur, McIntosh Laboratory

Or one of its authorized agencies will repair the defect at no cost to the purchaser. This guarantee does not extend to components damaged by improper use nor does it extend to transportation to and from the factory or service agency.

THREE YEAR FACTORYSERVICE CONTRACT

An application for a FREE THREE YEAR FACTORY SERVICE CONTRACT is included with this manual. The terms of the contract are:

1. McIntosh will provide all parts, materials and labor needed to return the measured performance of the instrument to the original performance limits free of any charge. The SERVICE CONTRACT does not cover any shipping costs to and from the authorized service agency or the factory.
2. Any McIntosh authorized service agency will repair all McIntosh instruments at normal service rates. To receive the free service under the terms of the SERVICE CONTRACT, the SERVICE CONTRACT CERTIFICATE must accompany the instrument when taken to the service agency.
3. Always have service done by a McIntosh authorized service agency. If the instrument is modified or damaged, as a result of unauthorized repair the SERVICE CONTRACT will be cancelled. Damage by improper use or mishandling is not covered by the SERVICE CONTRACT.
4. The SERVICE CONTRACT is issued to you as the original purchaser. To protect you from misrepresentation this contract cannot be transferred to a second owner.
5. The SERVICE CONTRACT is given to purchasers who live in the 50 United States or Canada only.
6. For your protection McIntosh selects its dealers carefully. Only one dealer in ten qualifies for a McIntosh franchise. To receive the SERVICE CONTRACT your purchase must be made from a McIntosh franchised dealer.
7. Your completely filled in application for a SERVICE CONTRACT must be postmarked within 30 days of the date of purchase of the instrument.
8. To receive the SERVICE CONTRACT all information on the application must be filled in. The SERVICE CONTRACT will be issued when the completely filled in application is received at McIntosh Laboratory Incorporated in Binghamton, New York. If the application is not received at McIntosh Laboratory, only the service offered under the 90-day guarantee will apply.



Adequate ventilation extends the trouble-free life of electronic instruments. It is generally found that each 10° centigrade (18° F) rise in temperature reduces the life of electrical insulation by one half. Adequate ventilation is an inexpensive and effective means of preventing insulation breakdown that results from unnecessarily high operating temperatures. The direct benefit of adequate ventilation is longer, trouble-free life.

Allow at least 15 inches deep x 17½ inches wide x 6 inches high for mounting the MA 5100. Always allow for air flow by either ventilation holes or space next to the bottom of the equipment and a means for a warm air to escape at the top.

It is recommended that it be mounted in a normal or horizontal position. However, with adequate ventilation the instrument can be mounted in any position.

To prepare the MA 5100 for installation remove the plastic protective covering. Turn the MA 5100 upside down so that it rests on its top on the shipping pallet. Remove the four plastic feet fastened to the bottom of the chassis.

The professional mounting design eliminates the need for any shelf or bracket to support the MA 5100. It is completely supported by its own mounting brackets.

Position the plastic mounting template over the area of the cabinet to be cut out for installation.

The design of the mounting template allows the cutout to be positioned or located from the front or rear of the panel to which the instrument is to be mounted.

If the cutout is to be located from the rear of the panel, the following steps will help you.

On the back of the cabinet panel, scribe a vertical centerline through the exact center of the area in which the cutout is to be made.

Place the template against the back of the panel and match the template centerline with the centerline on the cabinet panel.

Make sure that there is at least ¼ inch clearance between the bottom of the dashed line of the cutout area on the template and any shelf or brace below the proposed cutout.

Mark the two locating holes ("C" holes on the mounting template).

Drill the two locating holes. Be certain the drill is perpendicular to the panel.

Now position the template on the front of the panel by aligning the "C" locating holes on the template with the drill holes.

With template in place against the cabinet panel, mark the "A" and "B" drill holes and the four small holes that identify corners of the cutout. Join the corner marks with a pencil. The edge of the template can be used as a straight edge.

IMPORTANT: DRILL THE 6 HOLES BEFORE MAKING THE CUTOUT.

Accurately drill the three holes on each side of the cutout area with a 3/16 inch drill.

With the saw on the INSIDE OF THE PENCIL LINES carefully cut out the rectangular opening.

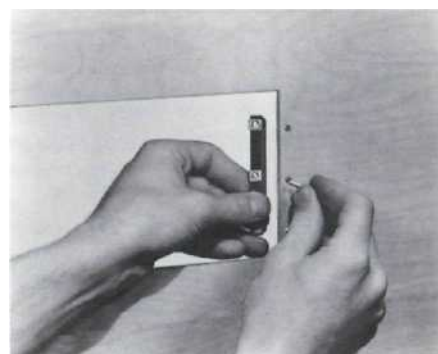

Secure the mounting strips to the rear of the cabinet panel using two screws from the hardware package.

Insert the screws in the center holes of the cabinet panel! ("B" holes on the template) and tighten. The screw head should pull into the wood slightly. (Use the two 3/8 inch long screws for panels under 1/2 inch, or two 1/2 inch long screws for panels 1/2 inch thick or larger.)

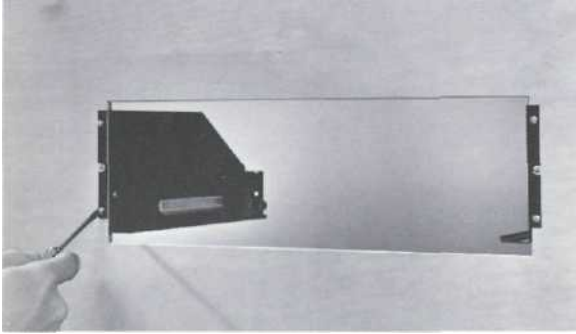

Attach the mounting brackets to the cabinet panel using four screws.

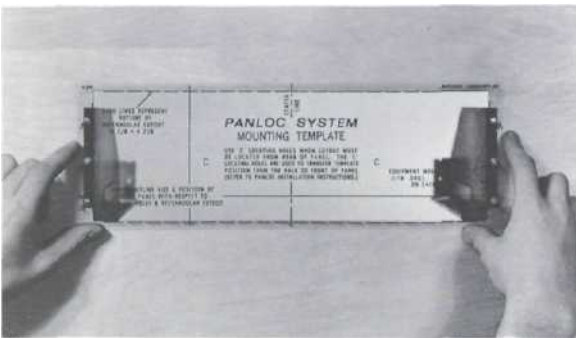

Place the template over the mounting screws. The mounting screws should be centered in the "A" and "B" holes on the template. The sides of the mounting brackets should match the vertical dash lines on the template. If necessary, loosen the screws and push the brackets into alignment and retighten.

Insert the power cord through the opening. Carefully slide the MA 5100 into the opening so the rails on the bottom of the equipment slide in the track of the mounting brackets. Continue to slide the instrument in until the front panel is against the cabinet panel.

Secure the instrument to the mounting brackets by inserting the two knurled headed screws (from the hardware package) into the back of the MA 5100 chassis. These screws pass through holes in the back flanges of the mounting brackets.

How to connect

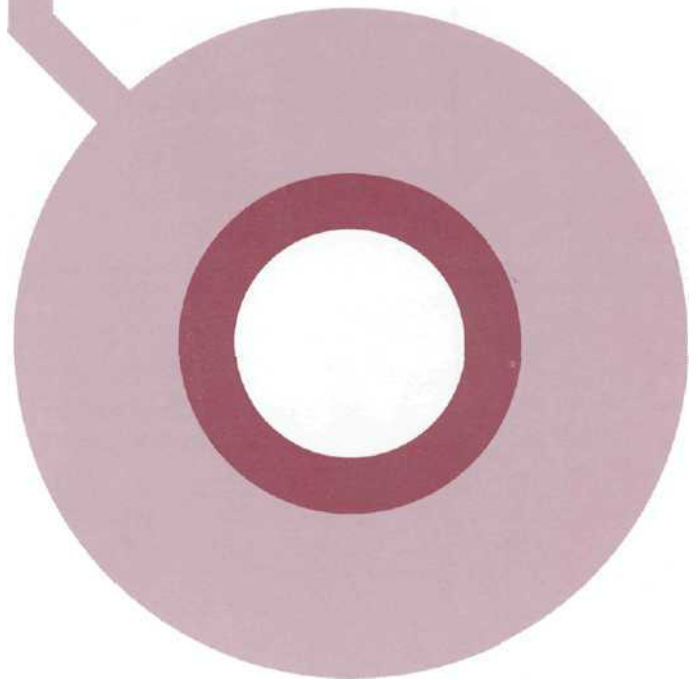

CONNECTING A LOUDSPEAKER

The MA 5100 is designed for stereo operation only. Do not connect the MA 5100 for monophonic operation. Damage to the loudspeaker may result.

Speakers are connected at the OUTPUT barrier strips on the back panel of the MA 5100.

Connect the leads from the left loudspeaker to the LEFT OUTPUT barrier strip. Connect the leads from the right loudspeaker to the RIGHT OUTPUT barrier strip. Use lamp cord, bell wire, or wire with similar type of insulation to connect the speakers to the amplifier. For the normally short distances of under 50 feet between the amplifier and speaker, #18 wire should be used. For distances over 50 feet between the amplifier and speaker use wire of a larger diameter (#16 or #14.)

CONNECTING TO THE AUXILIARY

Any high level program source such as another tuner or a TV set can be connected to the Auxiliary input jacks.

CONNECTING A TAPE RECORDER

To Record:

Connect a cable from the L TAPE OUTPUT to the left high level input on the tape recorder.

Connect a cable from the R TAPE OUTPUT to the right high level input of the tape recorder.

To Playback/Monitor:

Connect the cable from the left channel output of

How to Connect

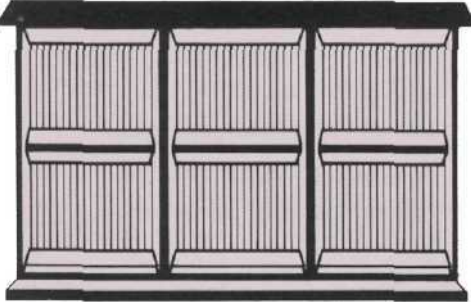
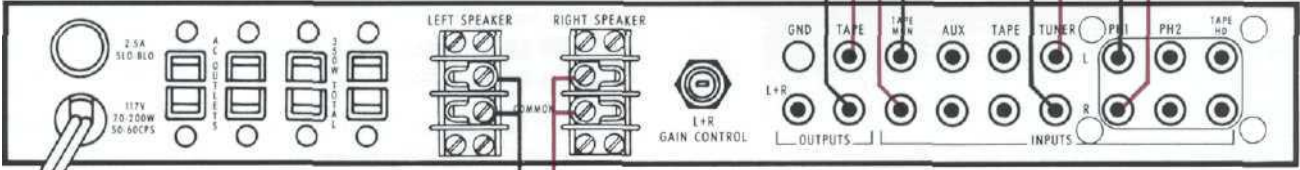
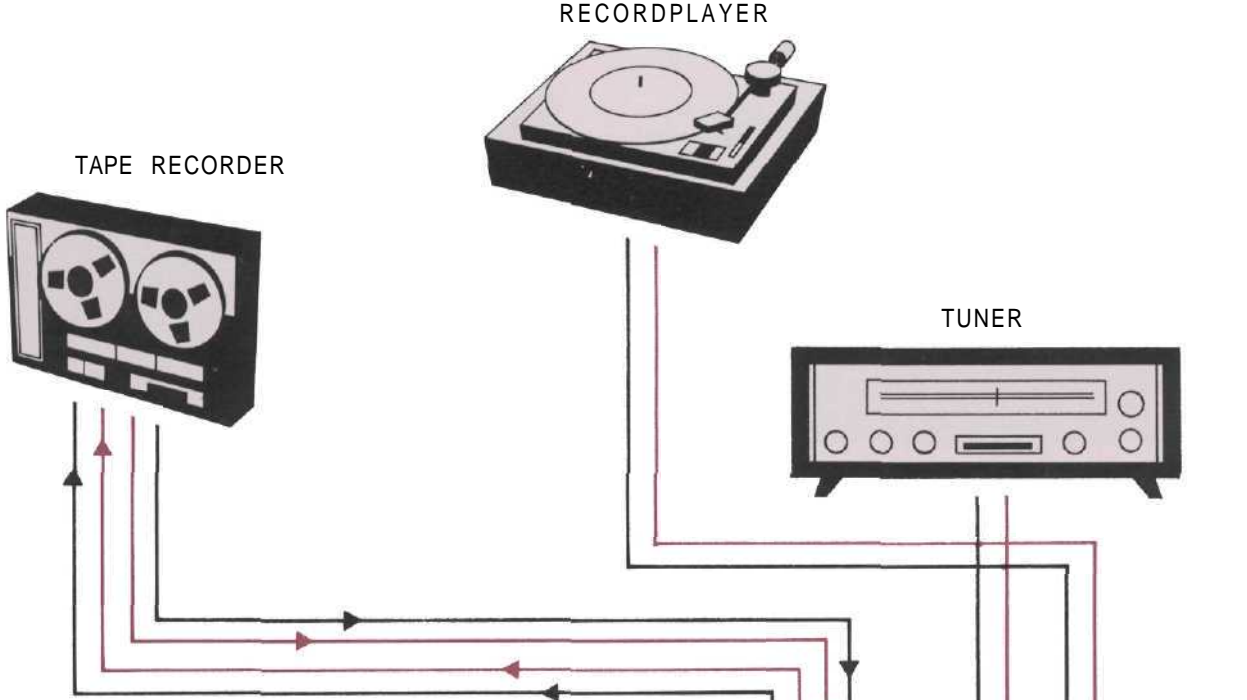

LEFT LOUDSPEAKER

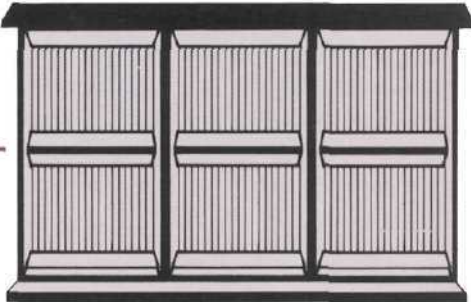

RIGHT LOUDSPEAKER

a tape recorder to the L TAPE MONitor input.

Connect the cable from the right channel output of a tape recorder to the R TAPE MONitor input.

CONNECTING A STEREO TUNER

Connect the cable from the left channel tuner output to the L TUNER input.

Connect the cable from the right channel tuner output to the R TUNER input.

CONNECTING A RECORD PLAYER TO PHONO 1

Connect the cable from the left channel of the record player into the L PHONO 1 input.

Connect the cable from the right channel of the record player into the R PHONO 1.

PHONO 2 is provided for the use of a second record player.

Connect the cable from the left channel of the record player into the L PHONO 2 input.

Connect the cable from the right channel of the record player into the R PHONO 2 input.

CONNECTING A TAPE DECK FOR PLAYBACK

Connect the cable from the left tape recorder

head on the tape deck (one without its own electronics) to the L TAPE HEAD input. Connect the cable from the right tape recorder head to the R TAPE HEAD input.

GROUND CONNECTION

A single GROUND post is provided. Grounds for turntables, record changers, tape decks, etc., should be connected to this post. The left and right program cables and the ground wire from that source should be wound or twisted together. To avoid hum, make sure the ground wire does not make any contact to the shields of the left and right program cables between the program source and the MA 51000. The only ground should be at the GROUND post on the rear of the MA 5100.

AC POWER OUTLETS

There are 3 black AC power outlets and one red outlet. The power to the black AC power outlets is controlled by the front panel power switch. Use these outlets for a tuner, tape recorder, etc. The red receptacle is on at all times. Use the red outlet for a turntable or record changer. The turntable or record changer is protected by this arrangement. It is necessary to turn off the turntable or record changer with its own AC power switch.

What the Controls Do and How to Use Them

INPUT SELECTOR

AUX: Connects the output from any high level program source requiring flat amplification to the high level input stages. Such a source could be a television set or other source that has output of 0.25 volts or more. In the AUX position the gain is 0 dB to the TAPE outputs. The input impedance is 250,000 ohms.

TAPE: Connects the output from a complete tape recorder to the high level input stages. In the TAPE position the gain to the TAPE OUTPUTS is 0 dB. The input impedance is 250,000 ohms.

TUNER: Connects the output from any AM, FM or FM STEREO tuner to the high level input stages. In the TUNER position the gain to the TAPE output is 0 dB. The input impedance is 250,000 ohms.

PHONE 1: Connects the output of any magnetic phono cartridge to the low level input stages. The response has been shaped to compensate for the characteristics of magnetic phono cartridges. The gain at 1000 Hz is 42 dB to the TAPE outputs. The input impedance is 47,000 ohms.

PHONE 2: Same as PHONO 1.

Tape Hd: Connects the output of any tape head (a tape deck without its own electronics) to the low

level input stages. The response has been shaped to compensate for the characteristics of the tape head. The gain at 500 Hz is 44 dB to the TAPE outputs. The input impedance is 500,000 ohms.

BASS

The BASS is a concentric control. The outer knob controls the low frequency response in the right channel. The center knob controls the low frequency response in the left channel. The two knobs are friction coupled. This permits them to be adjusted together or independently. Clockwise rotation increases lows and counterclockwise decreases lows. Turn control to the center position for flat response.

TREBLE

The TREBLE is a concentric control. The outer knob controls the high frequency response in the left channel. The center knob controls the high frequency response in the right channel. The two knobs are friction coupled. This permits them to be adjusted together or independently. Clockwise rotation increases highs and counterclockwise decreases highs. Turn the control to the center position for flat response.

VOLUME

The VOLUME control regulates the loudness in both channels. The VOLUME control has been pre-



cision tracked throughout the listening range (0 to -65 dB) for accurate stereo balance.

MODE SELECTOR: Connects the input program to the loudspeaker in any of the following seven ways:
L to L & R: Connects the left input to both loudspeakers.

R to L & R: Connects the right input to both loudspeakers.

STEREO REV: Connects the left input to the right loudspeaker and the right input to the left loudspeaker.

STEREO: Connects the left input to the left loudspeaker and the right input to the right loudspeaker.

MONO (L + R): adds the left input and the right input and then connects the L + R program to both loudspeakers.

L + R to L: Connects the left plus right program to the left loudspeaker only.

L + R to R: Connects the left plus right program to the right loudspeaker only.

COMPensation

Use the COMP switch to correct for phono equalization introduced in the recording process. All current stereo recordings use RIAA equalization. Some early stereo and mono recordings use LP equalization.

TAPE: The TAPE switch makes it possible to instantaneously compare recorded material with the signal source. Tape jacks on the back panel are designed to accept a signal from a tape recorder with a monitor head and preamplifier.

NORMAL . . . the program source is fed through the power amplifiers and the loudspeakers.

MONITOR . . . the signal source becomes the recorded tape and is fed through the power preamplifiers and loudspeakers.

When the switch is in the MONITOR position a triangle is lighted above the switch. When the light is on only the tape can be heard. To listen normally the light must be off.

PHASE: Electronically reverses phase in the left channel to correct "out of phase" program sources.

SPEAKER: For private listening on headphones the loudspeakers can be turned off. When the switch is in the OFF position a triangle is lighted above the switch. When the light is on sound will not be heard from the speakers. Only the headphones will be heard.

POWER: The POWER switch controls the AC input power. It turns the MA 5100 on and off. The switch also controls the three black AC outlets on the back panel.

L. F. (LOW FREQUENCY FILTER): Use the L. F. filter switch to reduce objectionable low-frequency noise

created by a turntable or record changer and acoustically coupled feedback.

FLAT . . . filter disconnected.

FILTER . . . low frequency rumble and noise below 50 Hz are reduced when the switch is in the FILTER position.

H. F. (HIGH-FREQUENCY FILTER): Use the H. F. filter switch to reduce objectionable high-frequency noise such as record scratch.

FLAT . . . filter disconnected.

FILTER . . . high frequency noises above 5000 Hz are reduced when the switch is in the FILTER position.

LOUDNESS

When the volume is reduced, the music will seem to lose much of its bass and some of its treble. This effect is due to the sensitivity characteristic of human hearing. The response of the human ear to bass tones decreases more rapidly than its response to notes centered in the mid-tonal range. The LOUDNESS control automatically provides the correct amount of bass required to compensate for this change in response of the human ear at low-loudness levels. In the COMPENSATED position the volume control is converted to a loudness compensated control. Use this position to listen at low volume and still hear full-bass response.

BALANCE

The BALANCE CONTROL adjusts for unequal volume in either the left or right channels. The volume of each channel can be varied relative to each other without affecting their combined loudness.

LEFT . . . turning the control to the left accents the left channel by reducing the right channel output.

RIGHT . . . turning the control to the right accents the right channel by reducing the left channel output.

Balancing your Stereo

The performance and enjoyment of a stereo system is greatly increased when the sound is properly balanced. The balance of the stereo system is affected by many things including room acoustics, furniture placement, room shape, small differences in loudspeakers, etc. To assist you in balancing your stereo system in your room here is the procedure to determine correct phase and program loudness.

TO ADJUST PHASE

1. Play a familiar record.
2. Press the MODE pushbutton to the MONO position.
3. Turn BALANCE control to 12 o'clock position.
4. Stand about 10 feet in front of and midway between the loudspeakers. The sound should appear to come from directly in front of you. If the sound is not directly in front of you with the PHASE switch in the NORMAL position, reverse the leads on one loudspeaker. When the sound comes from directly in front of you the speakers are in PHASE. Use the PHASE switch to correct for out of phase program sources.

TO BALANCE LOUDNESS

1. Press the MODE pushbutton to the MONO position.
2. Play a familiar record.
3. Turn the BALANCE control to the 12 o'clock position.
4. While the program is playing, stand between the two loudspeakers. Listen for a difference in loudness between speakers. Next, set the MODE selector to STEREO. If there is then a difference in loudness turn the BALANCE control toward the speaker that is not as loud. Adjust the BALANCE control until the sound is satisfactory between both speakers.



Listening to Your Stereo

LISTENING TO A STEREO RECORD

Turn the INPUT SELECTOR to PHONO 1 and PHONO 2, whichever is connected to the record player you wish to hear.

Make certain the MODE SELECTOR is in the STEREO or STEREO REVERSE position.

Adjust the VOLUME control to desired volume.

LISTENING TO A MONOPHONIC RECORD

Turn the INPUT SELECTOR to PHONO 1 or PHONO 2, whichever is connected to the record player you wish to hear.

Turn the MODE SELECTOR to MONO (L + R).
Adjust the VOLUME control to desired volume

LISTENING TO A STEREO TAPE RECORDER

Turn the INPUT SELECTOR to TAPE.

Set the MODE SELECTOR to STEREO or MONO, depending on the program on the tape.

Adjust the VOLUME control to desired volume.

TO RECORD ON A STEREO TAPE RECORDER

All program sources are available at the TAPE OUTPUT jacks. The program material is unaffected by all front panel controls except the INPUT SELECTOR.

To monitor while recording, the tape recorder must have separate record and playback or monitor heads. The TAPE switch permits monitoring the tape recordings while in the process of recording. When the TAPE switch is at the MONITOR position it will play the sound from the tape as it passes the playback head, a moment after it is recorded. The recording process continues as usual. When the TAPE switch is at the NORMAL position the program being recorded is heard.

LISTENING TO TAPE DECKS

To listen to tape from a tape deck, proceed as follows:

Turn the INPUT SELECTOR to TAPE HD.

Turn the MODE SELECTOR to MONO (L + R) or STEREO, depending on the program on the tape.

Adjust the VOLUME control to the desired volume.

LISTENING TO HEADPHONES

The HEADPHONE jacks have been designed to feed low impedance dynamic headphones. Electrostatic headphones generally require higher power than dynamic headphones. They must be connected to the LEFT and RIGHT OUTPUT barrier strips on the back of the MA 5100.

Performance Limits

Performance Limits are the maximum deviation from perfection permitted for a McIntosh instrument. We promise you that your MA 5100 must be capable of performance at or exceeding these limits or you get your money back. McIntosh is the only manufacturer that makes this guarantee.

POWER OUTPUT

45 RMS watts continuous per channel into 4 or 8 ohms both channels operating 20 Hz to 20,000 Hz.

30 RMS watts continuous per channel into 16 ohms both channels operating 20 Hz to 20,000 Hz.

HARMONIC DISTORTION

Does not exceed 0.25% at rated power output from 20 Hz to 20,000 Hz with both channels operating. Typical performance is less than 0.1% at rated power. Distortion decreases as output power is reduced.

INTERMODULATION DISTORTION

Does not exceed 0.25% if instantaneous peak power output is twice rated power or less per channel with both channels operating for any combination of frequencies 20 Hz to 20,000 Hz.

OUTPUT IMPEDANCE

4, 8, or 16 ohms

DAMPING FACTOR

50 with 4 ohms load, 100 with 8 ohms load, 200 with 16 ohms load

FREQUENCY RESPONSE

10 Hz to 20,000 Hz +0 —0.5 db at rated power
8 Hz to 50,000 Hz +0 —3.0 dB at rated power

INPUT IMPEDANCE

Auxiliary, TAPE, TUNER, and TAPE MONITOR:
250,000 ohms

PHONO 1 and PHONO 2: 47,000 ohms

TAPE HEAD: 500,000 ohms

INPUT SENSITIVITY

Auxiliary, TAPE, TUNER, and TAPE MONITOR:
0.3 volts

PHONO 1 and PHONO 2: 2 mV

TAPE HEAD: 2 mV

TOTAL NOISE

TOTAL NOISE (INCLUDING POWER AMPLIFIER)
Auxiliary, TAPE, TUNER, and TAPE MONITOR: 75 dB below rated output

PHONO 1, PHONO 2 and TAPE HEAD: 70 dB be-

low 10 mV input; equivalent to less than 3 microvolts at input.

TAPE OUTPUT

0.3 volts with rated input, less than 150 ohms source impedance, to operate in 47,000 ohms or greater.

VOLTAGE AMPLIFICATION IN DECIBELS

Auxiliary, TUNER, and TAPE to TAPE OUTPUT; 0 dB

PHONO 1 and PHONO 2 at 1000 Hz to TAPE OUTPUT: 42 dB

TAPE HEAD at 500 Hz to TAPE OUTPUT; 44 dB

LEFT PLUS RIGHT OUTPUT

Adjustable 0 to 6 volts from generator impedance of 5,000 ohms.

BASS CONTROLS

±18 dB at 20 Hz, with friction clutch for independent adjustment of each channel.

TREBLE CONTROLS

±18 dB at 20,000 Hz with friction clutch for independent adjustment of each channel.

HF FILTER

Flat, or 5,000 Hz cutoff, 12 dB per octave.

LF FILTER

Flat, or 5,000 Hz cutoff 12 dB per octave.

SEMICONDUCTOR COMPLEMENT

23 Silicon Rectifiers and Diodes
34 Silicon Transistors
2 Silicon Bilateral Switches
2 TRIAC

POWER REQUIREMENTS

120 volts, 50 60 Hz, 70 watts at zero signal output, 200 watts at rated output

MECHANICAL INFORMATION

SIZE; Front panel, 16 inches wide by 5 7/16 inches high; chassis, 15 inches wide by 4½ high by 14½ deep, including connectors. Clearance in front of mounting panel including knobs, 1½ inches.

WEIGHT: 25 pounds net, 41 pounds in shipping carton.

FINISH: Front Panel: Anodized gold and black: Chassis: Chrome and black.

FACILITIES AND FEATURES

INPUT SELECTOR: Select from six sources—Auxiliary, TAPE, TUNER, PHONO 1, PHONO 2, or TAPE HD

BASS: The low frequency program material is modified to suit your taste. Right Channel is the outer knob, the left channel is the inner knob.

TREBLE: The high frequency program material is modified to suit your taste. Right channel is the outer knob, the left channel is the inner knob.

VOLUME: Precision tracked at all listening levels. (0 to —65 dB.) Does not change stereo balance as loudness is changed.

MODE SELECTOR: Seven positions: Left channel only to both speakers, Right channel only to both speakers, Stereo Reverse, Stereo, Mono, L + R to left speaker only, L + R to right speaker only.

COMPensation: Select from two circuits that tailor the response to correct for the characteristics used in the recording of phonograph records.

TAPE: Monitor the recorded program from the tape or hear the program that is being recorded.

PHASE: Electronically reverse phase in the left channel to correct "out of phase" program sources.

SPEAKER: Switch the loudspeaker system ON or OFF without affecting the performance of headphone jacks.

LF FILTER (Rumble Filter): Flat or roll-off 12 dB per octave above 5,000 Hz, down 12 dB at 20,000 Hz.

LOUDNESS: COMPENSATED position boosts low frequencies for low level listening. Operates as a function of volume control rotation so full compensation is obtained at lower volume levels and flat response is obtained at full volume.

BALANCE: Natural balance at center position, attenuation of left or right channel by rotating control.

Typical Performance Charts

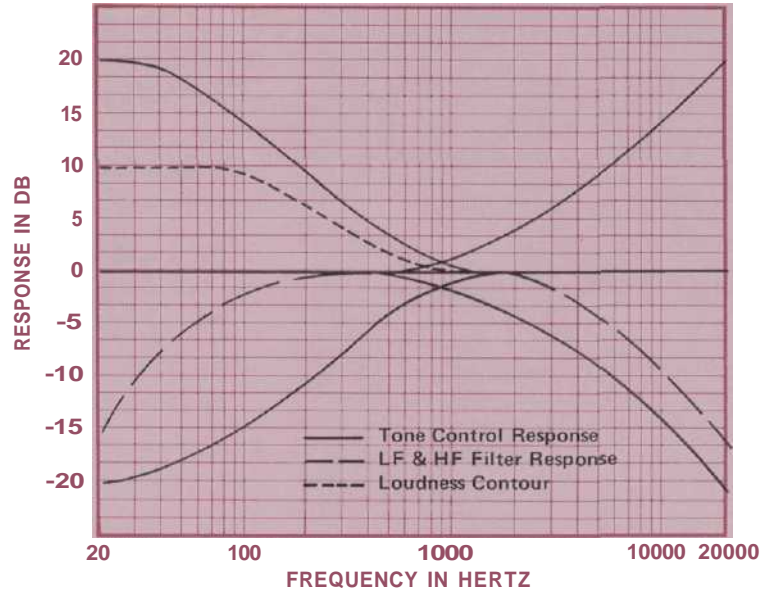

POWER VS. FREQUENCY

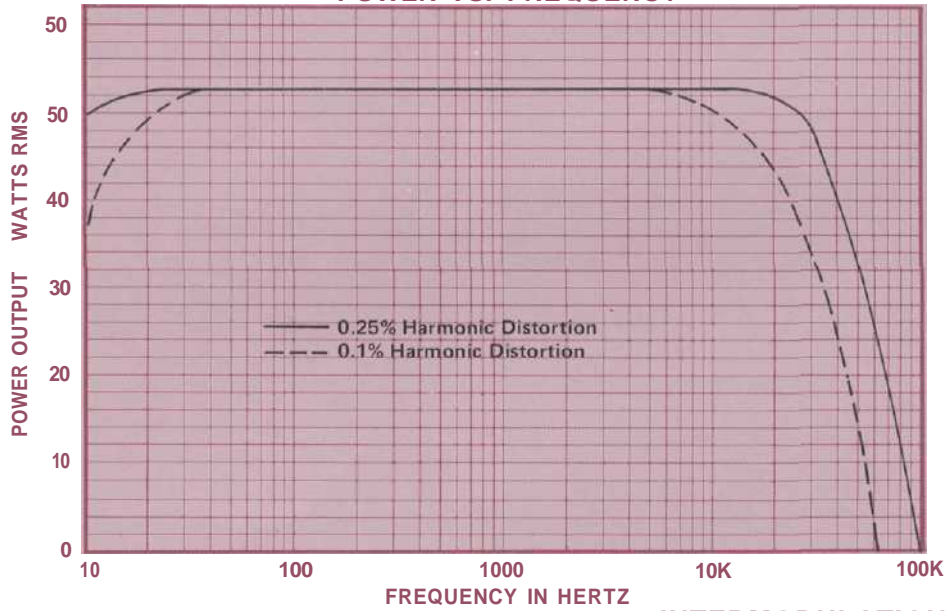

HARMONIC DISTORTION VS. FREQUENCY

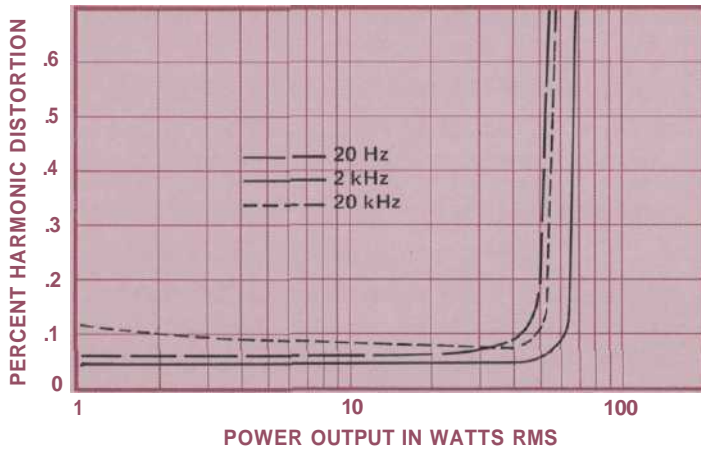

INTERMODULATION DISTORTION VS. EQUIVALENT POWER OUTPUT

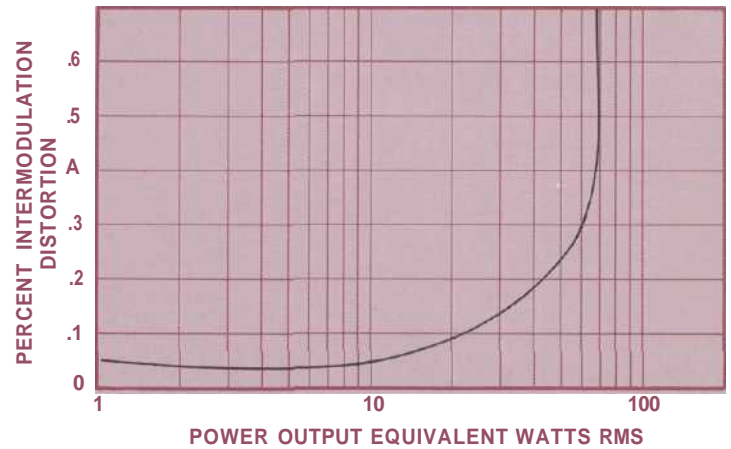

Technical Description

PREAMPLIFIER SECTION

The phono and tape head preamplifier circuits in the MA 5100 have three transistors in each channel. The input selector switch connects the input jacks to the first voltage gain stage of the preamplifier. The input stage has high voltage gain and very low noise. The next stage, an emitter follower, acts as an impedance converter that matches the input stage to the second voltage amplifier. The emitter follower is direct coupled to the second voltage amplifier.

Negative feedback is used around the low level section to reduce noise and distortion to an absolute minimum. The negative feedback also provides precise frequency compensation for magnetic phono cartridges and tape heads. The feedback remains in effect through the entire audio bandwidth, even at 20 Hz where gain is the highest. This kind of careful McIntosh engineering assures you of lowest distortion performance.

The tape head input impedance is 500,000 ohms. High tape head impedance permits uniform high frequency performance from typical tape transport playback heads.

The MA 5100 is ideal for tape recording. With an input signal from a phono cartridge of 10 millivolts, there is 1.4 volts available at the tape output jacks.

Phono input signal overload is virtually impossible. At 1,000 Hz the phono input will accept greater than 125 millivolts without overloading. This is more than 4 times the output from most phono cartridges when playing a low distortion phonograph record.

The phono input impedance is 47,000 ohms. This matches the impedance of magnetic cartridges.

The preamplifier output is connected by the input selector switch to the tape output, the tape monitor switch, the balance control, the loudness compensation switch, and the first section of the volume control. This arrangement permits recording of the program without interruption and has the ability to monitor the recorded tape.

The use of a two section volume control performs two important functions. First, the input section of the volume control increases the signal handling capability of the tone control amplifier. Use of this arrangement makes overdriving the tone control amplifier almost impossible. Second, the output volume control assures maximum signal to noise ratio regardless of the volume control position.

The tone control stages are made up of a three stage amplifier. The first two transistors are emitter

followers. The first emitter follower is driven from the output of the volume control. The second emitter follower is direct coupled to the third stage. The third stage is a high gain voltage amplifier.

Signals pass through the input emitter follower and then couple to the second and third tone control stages through the tone control network. The tone control contours are obtained by controlling the large negative feedback around the second and third transistors. This negative feedback is used to accurately shape the response. The large amount of negative feedback also makes possible low distortion from the tone control amplifier.

The output of the tone shaping amplifier drives the low frequency and high frequency filters and the second section of the volume control. The filters are designed to remove unwanted noises such as turntable rumble and record scratch. The filters remove the maximum amount of objectionable material and still have a minimum effect on the musical content of the program material.

The output of the volume control is fed to a two stage voltage amplifier that has very low noise characteristics. Negative feedback is used to improve the signal to noise ratio and assure an absolute minimum of distortion.

The phase switch is part of the left channel circuit. The switch selects from two sources that are of equal amplitude but are "out of phase" to each other. In the normal position the phase is the same in both channels. When the phase switch is in the 180° position the left channel is "out of phase" when compared to the right. Out of phase program source material is easily corrected with the use of this switch.

Block Diagram

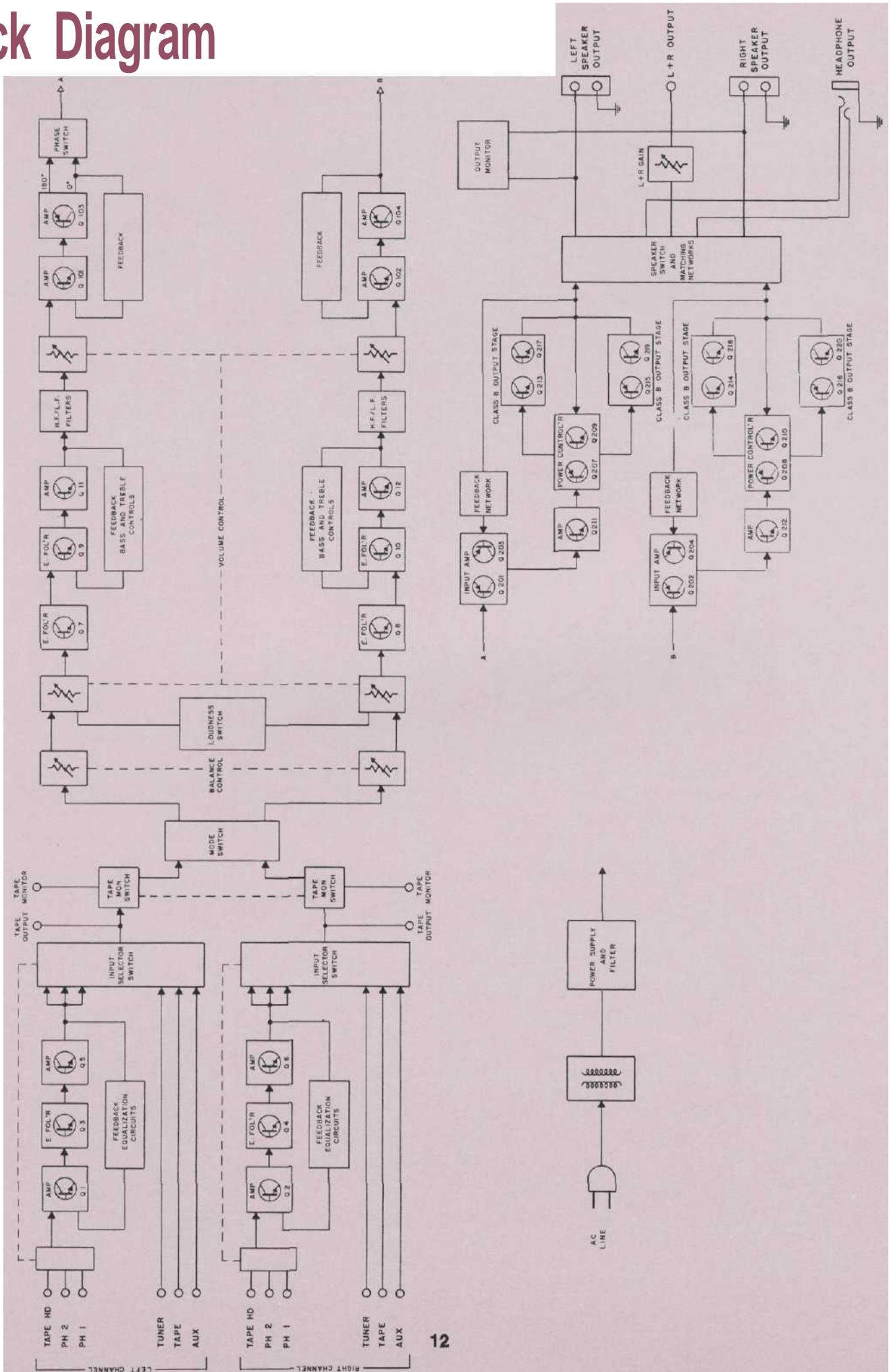

McIntosh

McINTOSH LABORATORY INC.

2 CHAMBERS ST., BINGHAMTON, N. Y. 13903

607-723-3512

Design subject to change without notice.

Printed in U.S.A.

Be112002

038-605